

Caratteristiche generali / Technical characteristics		
	l/min	GPM
• Portata nominale / Nominal flow	140	37
• Portata limite / Max flow	180	48
	bar	PSI
• Pressione nominale / Nominal pressure	250	3600
• Pressione max sugli utilizzi / Max pressure on ports	320	4700
• Contropressione max allo scarico / Max pressure in tank-line	80	1100



P-T - TEMPERATURA OLIO 50°C - VISCOSITÀ 3,5°E

P-A/B - TEMPERATURA OLIO 50°C - VISCOSITÀ 3,5°E

A/B-T - TEMPERATURA OLIO 50°C - VISCOSITÀ 3,5°E

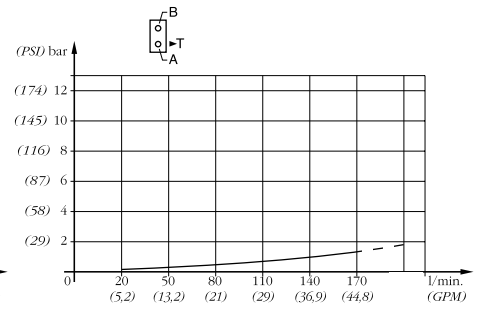
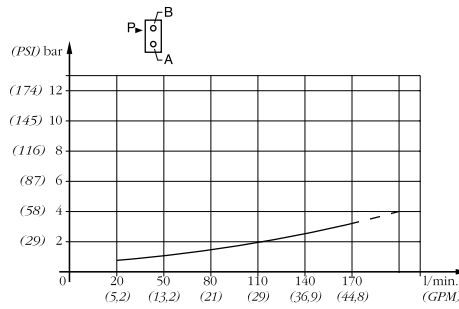
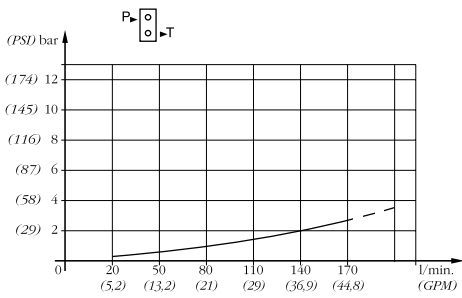

Possibilità di valvole ausiliarie (vedi schema)
Possibility to have auxiliary valves (see diagram)

VL = limitatrici di pressione	VL = relief valve
VC = anticavitazione	VC = anticavitation valve
VLC = limitatrice e anticavitazione	VLC = combined relief and anticavitation

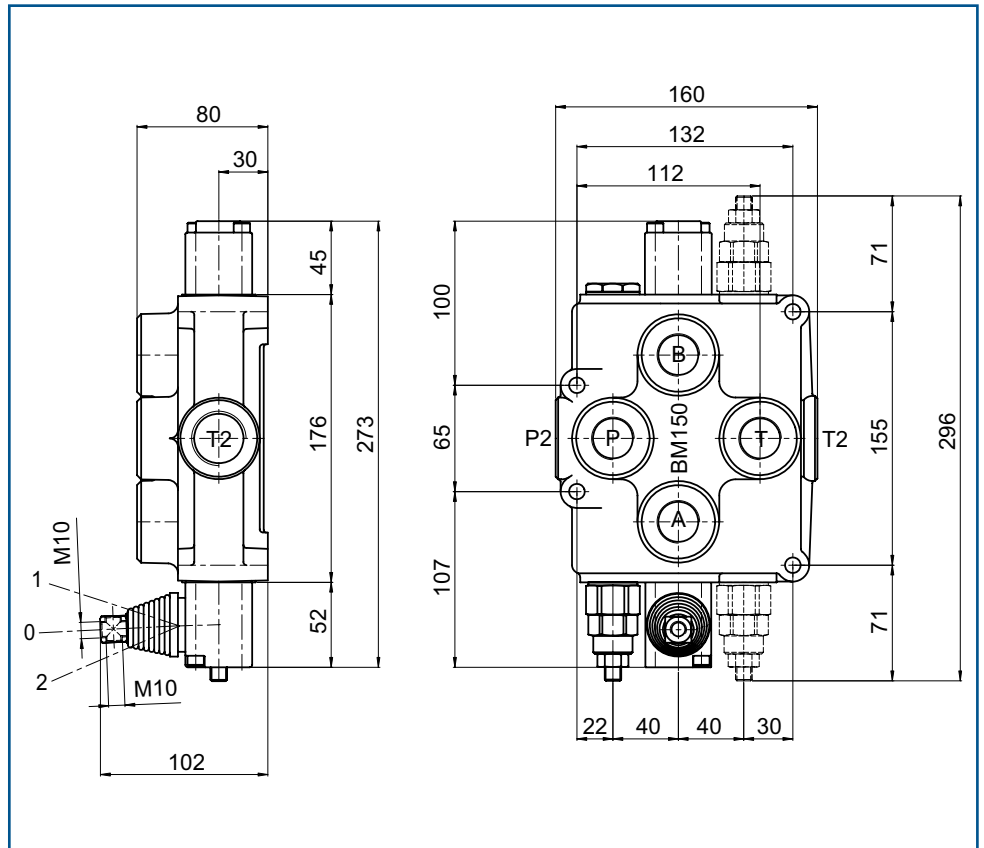
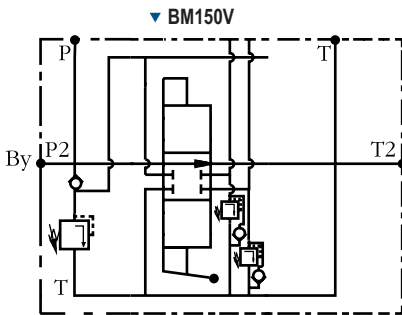

MOD	L	I	Kg
BM150			8,2

FILETTATURA STANDARD - STANDARD THREADS					
COD	A-B	P	T	P ₂	T ₂
G	3/4"	3/4"	3/4"	1"	1"
F	1.1/16" - 12	1.1/16" - 12	1.1/16" - 12	1.5/16" - 12	1.5/16" - 12

◀ Su richiesta filettature diverse
Other threads available on request

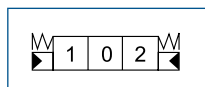
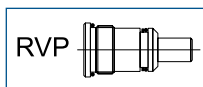
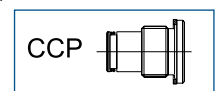
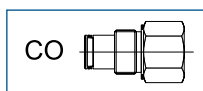
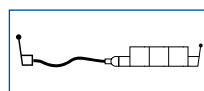
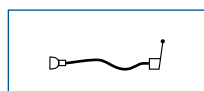
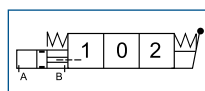
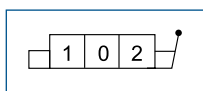

CONFIGURAZIONI DISPONIBILI

AVAILABLE CONFIGURATIONS

COD	CIRCUITO SPOOL TYPE	BM10	BM20	BM30	BM70	BM150	BC35	BC60
			BF20	BM40	BC70	BC150		
			BC20	BF40	BF70	BC180		
			BM25	BM45	BM100			
			BM35	BM50	BC50			
A		●	●	●	●	●		
B		●	●	●	●	●		
C		●	●	●	●	●		
D		●	●	●	●	●		
E		●	●	●	●	●		
F		●	●	●	●	●		
K		●	●	●	●	●		
L				●	●			
M		●	●	●	●	●		
R		●		●	●			
Y			●	●				
Z		●		●	●			
AE			●	●	●		●	●
BE			●	●	●			●
DE			●	●	●		●	●

12		12 VOLT DC			●	●		●	●
24		24 VOLT DC			●	●		●	●

COD	VALVOLAMAX RELIEF VALVE	CAMPO DI TARATURA CALIBRATION FIELD bar (psi)	TARATURA STANDARD CALIBRATION bar (psi)	BM10	BM20	BM30	BM70	BM150	BC35	BC60
					BF20	BM40	BC70	BC150		
					BC20	BF40	BF70	BC180		
					BM25	BM45	BM100			
					BM35	BM50	BC50			
X		10-90 (145-1305)	70 (1015)	●	●	●	●	●	●	●
U		90-250 (1305-3626)	140 (2030)	●	●	●	●	●	●	●
K		150-300 (2175-4351)	200 (2900)	●	●	●	●	●	●	●

Taratura standard effettuata con pompa 5 lt/min.
Standard calibration made with a 5 lt/min. pump

COD	POSIZIONATORE SPOOL CONTROL	BM10	BM20	BM30	BM70	BM150	BC35	BC60
			BF20	BM40	BC70	BC150		
			BC20	BF40	BF70	BC180		
			BM25	BM45	BM100			
			BM35	BM50	BC50			
1		●	●	●	●	●		
2		●	●	●	●	●		
3		●	●	●	●	●		
4		●	●	●	●	●		
5		●	●	●	●	●		
6		●	●	●	●	●		
7		●	●	●	●	●		
8		●	●	●	●	●		
9		●	●	●	●	●		
10		●	●	●	●	●		
11		●	●	●				
12				●	●			
13			●	●				
14				●	●			
16		●	●	●				
1E			●	●	●		●	●
1EA			●	●	●			
1EB			●	●	●			